

2023

SECO TOOLS PRODUCTIVITY KITS



BUNDLE AND SAVE

SECO 



**PRODUCTIVITY
KITS FOR EVERY
APPLICATION**

SAVE ON INVENTORY COSTS GET PRODUCTIVITY KITS FROM SECO TOOLS

Save on the tools you use most with these economical Productivity Kits! We have hand selected our most popular milling cutters, turning tools, and drill bodies with a pack of our best-selling inserts to give you the most aggressive discounts possible.* Get unbeatably low prices for the tools you know and trust.



*Pricing is at the discretion of the manufacturer and is subject to change without notice.

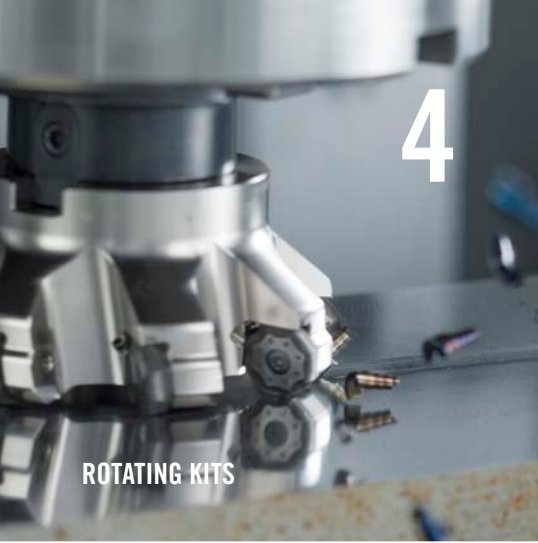

4

ROTATING KITS



19

DRILLING / HOLEMAKING KITS



SECO TOOLS PRODUCTIVITY KITS

WHAT'S INSIDE



12

STATIONARY KITS

LOOK INSIDE

SQUARE SHOULDER MILLING

Square 6™	5
Turbo 6 & 10	6
Turbo 12 & 16	7
Double Turbo 16.....	8

FACE MILLING

Double Quattromill™ 14.....	9
Quattromill™ 12	10

HIGH FEED MILLING

High Feed 2.....	11
------------------	----

TURNING

Duratomic® - Steel.....	13
Duratomic® TM Grades	14
Jetstream Tooling® Duo	
Superalloys	15

MDT, GROOVING & CUT-OFF

MDT & X4	16
150.10.....	17

THREADING

Internal & External.....	18
--------------------------	----

DRILLING/HOLEMAKING

Perfomax®.....	20
Feedmax™ -P.....	21
Crownloc® Plus.....	22

BUNDLE & SAVE

Increase your productivity in square shoulder or face milling applications and various materials with rotating kits from Seco Tools.

For a full product range, see our Indexable Milling Machining Navigator or visit: SECOTOOLS.COM

SQUARE SHOULDER & FACE MILLING ROTATING KITS



SECO 



SQUARE SHOULDER MILLING

SQUARE 6™ KITS

INCREASE PRODUCTIVITY & COST EFFICIENCY WITH SIX-SIDED INSERTS

The **Square 6** system is a series of square shoulder mills that utilizes a trigon shaped insert offering 6 cutting edges on a 90° square shoulder mill. With six cutting edges, Square 6 is a cost-effective tool for square shoulder milling, face milling and plunging.

R217/220.96-08 CUTTERS & XNEX INSERTS - MAX DEPTH OF CUT 0.295"

ITEM NUMBER	KIT DESCRIPTION	KIT CONTENTS						KIT PRICE (USD)	KIT PRICE (CAD)
		CUTTER	DIA	BORE	SHANK	INSERT (10 PCS.)			
02693016	SQUARE6-08 2.0P KIT	R220.96-02.00-08-5A	2.000	0.750	-	XNEX 080608TR-M13 MP2501	\$635	\$812	
02693018	SQUARE6-08 3.0P KIT	R220.96-03.00-08-7A	3.000	1.000	-	XNEX 080608TR-M13 MP2501	\$845	\$1,080	
02693019	SQUARE6-08 4.0P KIT	R220.96-04.00-08-8A	4.000	1.000	-	XNEX 080608TR-M13 MP2501	\$952	\$1,230	
02693021	SQUARE6-08 2.0M KIT	R220.96-02.00-08-5A	2.000	0.750	-	XNEX 080608R-M08 F40M	\$635	\$812	
02693023	SQUARE6-08 3.0M KIT	R220.96-03.00-08-7A	3.000	1.000	-	XNEX 080608R-M08 F40M	\$845	\$1,080	
02693024	SQUARE6-08 4.0M KIT	R220.96-04.00-08-8A	4.000	1.000	-	XNEX 080608R-M08 F40M	\$952	\$1,230	

Kits include one cutter body, ten inserts, and a wrench

FEATURED GRADES

- MP2501
- F40M

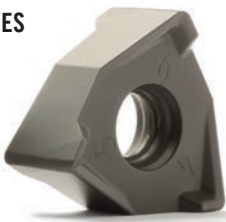

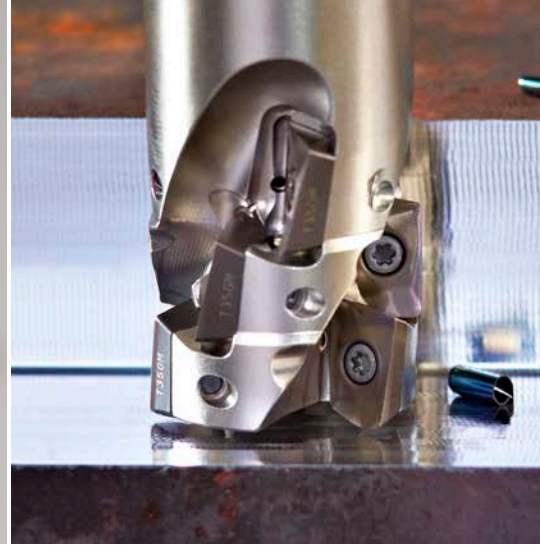

SQUARE SHOULDER MILLING

TURBO 6 & 10 KITS

PEAK PERFORMANCE IN LIGHT TO MEDIUM-DUTY OPERATIONS

Optimize your cutting properties with Seco's Turbo family of cutters that reduce heat generation and cutting forces. These cutters are available in a variety of configurations, all with copy milled pockets for insert stability and two pitch configurations to tackle almost every material. For small diameter square shoulder milling, **Turbo 6** will meet your needs, while the **Turbo 10** is your answer for light-duty high-precision applications. Both solutions can perform multiple milling functions, including ramping and helical interpolation.



R220.69-06 CUTTERS & XOMX INSERTS - MAX PROFILING DEPTH OF CUT 0.197"

	ITEM NUMBER	KIT DESCRIPTION	KIT CONTENTS				KIT PRICE (USD)	KIT PRICE (CAD)
			CUTTER	DIA	SHANK	INSERT (10 PCS.)		
P	02504118	TURBO6 .375P KIT	R217.69-00.375-0-06-2AN	0.750	0.375	XOMX 060208R-M05 F40M	\$337	\$428
	02504119	TURBO6 .500P KIT	R217.69-00.500-0-06-3AN	0.500	0.500	XOMX 060208R-M05 F40M	\$349	\$450

R217.69-10 CUTTERS & XOMX/XOEX INSERTS - MAX PROFILING DEPTH OF CUT 0.354"

	ITEM NUMBER	KIT DESCRIPTION	KIT CONTENTS				KIT PRICE (USD)	KIT PRICE (CAD)
			CUTTER	DIA	SHANK	INSERT (10 PCS.)		
P	02840165	TURBO10 .625P KIT	R217.69-00.625-3-10-2A	0.625	0.625	XOMX 10T308TR-M09 MP2501	\$401	\$511
	02840166	TURBO10 .750P KIT	R217.69-00.750-3-10-2A	0.750	0.750	XOMX 10T308TR-M09 MP2501	\$413	\$530
	02840167	TURBO10 1.00P KIT	R217.69-01.00-3-10-4A	1.000	1.000	XOMX 10T308TR-M09 MP2501	\$458	\$584
M	02840170	TURBO10 .625M KIT	R217.69-00.625-3-10-2A	0.625	0.625	XOEX 10T308R-M06 F40M	\$427	\$544
	02840171	TURBO10 .750M KIT	R217.69-00.750-3-10-2A	0.750	0.750	XOEX 10T308R-M06 F40M	\$445	\$570
	02840172	TURBO10 1.00M KIT	R217.69-01.00-3-10-4A	1.000	1.000	XOEX 10T308R-M06 F40M	\$484	\$618

Kits include one cutter body, ten inserts, and a wrench

FEATURED GRADES

- MP2501
- F40M



SQUARE SHOULDER MILLING

TURBO 12 & 16 KITS



HIGH PERFORMANCE MILLING IN LARGER DEPTH APPLICATIONS

Turbo 12 is the first-choice cutter for general-purpose square shoulder milling applications. The Turbo 12 is ideal in all applications from low carbon steels to high-temp alloys.

Reduce your power consumption, improve wall quality, get higher performance in sticky materials and increase ramp angles with the latest insert and pocket design of the **Turbo 16** cutters.



R217/220.69-12 CUTTERS & XOMX/XOEX INSERTS - MAX PROFILING DEPTH OF CUT 0.433"

	ITEM NUMBER	KIT DESCRIPTION	KIT CONTENTS					KIT PRICE (USD)	KIT PRICE (CAD)
			CUTTER	DIA	BORE	SHANK	INSERT (10 PCS.)		
P	02628260	TURBO 12 .750P KIT	R217.69-00.75-3-12-2AN	0.750	-	0.750	XOMX 120408TR-M12 MP2501	\$420	\$538
	02628263	TURBO 12 1.00P KIT	R217.69-01.00-3-12-3AN	1.000	-	1.000	XOMX 120408TR-M12 MP2501	\$445	\$570
	02628266	TURBO 12 1.25P KIT	R217.69-01.25-3-12-4AN	1.250	-	1.250	XOMX 120408TR-M12 MP2501	\$451	\$577
M	03019949	TURBO 12 1.50P KIT	R220.69-01.50-12-4AN	1.500	-	1.500	XOMX 120408TR-M12 MP2501	\$522	\$663
	02628261	TURBO 12 .750M KIT	R217.69-00.75-3-12-2AN	0.750	-	0.750	XOEX 120408R-M07 F40M	\$470	\$604
	02628264	TURBO 12 1.00M KIT	R217.69-01.00-3-12-3AN	1.000	-	1.000	XOEX 120408R-M07 F40M	\$476	\$611
	02628267	TURBO 12 1.25M KIT	R217.69-01.25-3-12-4AN	1.250	-	1.250	XOEX 120408R-M07 F40M	\$484	\$618
	03019952	TURBO 12 1.50M KIT	R220.69-01.50-12-4AN	1.500	-	1.500	XOEX 120408R-M07 F40M	\$552	\$704

Kits include one cutter body, ten inserts, and a wrench

R217/220.69-16 CUTTERS & XOMX INSERTS - MAX PROFILING DEPTH OF CUT = 0.491"

ITEM NUMBER	KIT DESCRIPTION	KIT CONTENTS					KIT PRICE (USD)	KIT PRICE (CAD)
		CUTTER	DIA	BORE	SHANK	INSERT (10 PCS.)		
10084223	TURBO 16 1.00P KIT	R217.69-01.00-3-X016-2A	1.00	-	1.00	XOMX160508TR-M13 MP2501	\$509	\$613
10084224	TURBO 16 1.25P KIT	R217.69-01.25-3-X016-3A	1.25	-	1.25	XOMX160508TR-M13 MP2501	\$533	\$643
10084225	TURBO 16 1.50P KIT	R217.69-01.50-3-X016-3A	1.50	-	1.50	XOMX160508TR-M13 MP2501	\$550	\$660
10084226	TURBO 16 2.00P KIT	R220.69-02.00-X016-5A	2.00	0.75	-	XOMX160508TR-M13 MP2501	\$689	\$825
10084227	TURBO 16 2.50P KIT	R220.69-02.50-X016-5A	2.50	0.75	-	XOMX160508TR-M13 MP2501	\$753	\$901
10084228	TURBO 16 3.00P KIT	R220.69-03.00-X016-6A	3.00	1.00	-	XOMX160508TR-M13 MP2501	\$851	\$1,020
10084229	TURBO 16 1.00M KIT	R217.69-01.00-3-X016-2A	1.00	-	1.00	XOMX160508TR-ME11 F40M	\$504	\$607
10084230	TURBO 16 1.25M KIT	R217.69-01.25-3-X016-3A	1.25	-	1.25	XOMX160508TR-ME11 F40M	\$528	\$630
10084231	TURBO 16 1.50M KIT	R217.69-01.50-3-X016-3A	1.50	-	1.50	XOMX160508TR-ME11 F40M	\$544	\$654
10084232	TURBO 16 2.00M KIT	R220.69-02.00-X016-5A	2.00	0.75	-	XOMX160508TR-ME11 F40M	\$683	\$819
10084233	TURBO 16 2.50M KIT	R220.69-02.50-X016-5A	2.50	0.75	-	XOMX160508TR-ME11 F40M	\$747	\$896
10084234	TURBO 16 3.00M KIT	R220.69-03.00-X016-6A	3.00	1.00	-	XOMX160508TR-ME11 F40M	\$840	\$1,010

FEATURED GRADES

- MP2501
- F40M

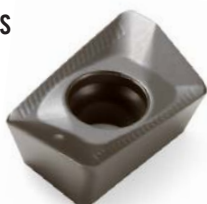

For cutting data recommendations and more visit: SECOTOOLS.COM





DOUBLE THE EDGES FOR IMPROVED PRODUCTIVITY

Achieve significant cost per edge savings with the 4 cutting edges of the double-sided Turbo. Use the most positive helix cutting angle geometry on the market for lower power consumption, smoother cutting and longer tool life. Together with high 90° angle accuracy and double-sided inserts, this generates a good surface finish and optimizes costs.

With precise geometry, the **Double Turbo 16** insert provides efficient chip evacuation and significantly reduces the generation of workpiece burrs, especially in steel, stainless steel, and titanium part applications. The insert cuts with less force so vibrations are minimized leading to extended tool life and smoother surface finish.

R217/R220.64-16 CUTTERS & ZOMX INSERTS - MAX PROFILING DEPTH OF CUT = 0.591"

ITEM NUMBER	KIT DESCRIPTION	KIT CONTENTS					KIT PRICE (USD)	KIT PRICE (CAD)
		CUTTER	DIA	BORE	SHANK	INSERT (10 PCS.)		
10083600	DBLETURBO 16 1.25P KIT	R217.64-01.25-3-Z016-2A	1.25	-	1.25	ZOMX160708TR-M12, MP2501	\$603	\$725
10015595	DBLETURBO 16 1.50P KIT	R217.64-01.50-3-Z016-3A	1.50	-	1.50	ZOMX160708TR-M12, MP2501	\$649	\$777
10015596	DBLETURBO 16 2.00P KIT	R220.64-02.00-Z016-4A	2.00	0.75	-	ZOMX160708TR-M12, MP2501	\$770	\$925
10015604	DBLETURBO 16 2.50P KIT	R220.64-02.50-Z016-5A	2.50	0.75	-	ZOMX160708TR-M12, MP2501	\$863	\$1,040
10015597	DBLETURBO 16 3.00P KIT	R220.64-03.00-Z016-6A	3.00	1.00	-	ZOMX160708TR-M12, MP2501	\$962	\$1,150
10083604	DBLETURBO 16 1.25M KIT	R217.64-01.25-3-Z016-2A	1.25	-	1.25	ZOMX160708TR-ME10, F40M	\$590	\$706
10015599	DBLETURBO 16 1.50M KIT	R217.64-01.50-3-Z016-3A	1.50	-	1.50	ZOMX160708TR-ME10, F40M	\$644	\$771
10015600	DBLETURBO 16 2.00M KIT	R220.64-02.00-Z016-4A	2.00	0.75	-	ZOMX160708TR-ME10, F40M	\$765	\$919
10015601	DBLETURBO 16 2.50M KIT	R220.64-02.50-Z016-5A	2.50	0.75	-	ZOMX160708TR-ME10, F40M	\$851	\$1,020
10015602	DBLETURBO 16 3.00M KIT	R220.64-03.00-Z016-6A	3.00	1.00	-	ZOMX160708TR-ME10, F40M	\$955	\$1,150

FEATURED GRADES

- MP2501
- F40M





REDUCE CUTTING FORCES & INCREASE DEPTH OF CUT

Maximize machine output and gain lower cost per cutting edge thanks to the double-sided, eight-edged inserts of the **Double Quattromill 14** face milling cutter. The specially developed and extremely free-cutting insert geometries lower cutting forces and require less machine power while also ensuring workpiece stability. Simplify processes and reduce inventory with these cost-effective double-sided inserts.



R220.54 CUTTERS & SNMX INSERTS - MAX DEPTH OF CUT 0.236"

	ITEM NUMBER	KIT DESCRIPTION	KIT CONTENTS				KIT PRICE (USD)	KIT PRICE (CAD)
			CUTTER	DIA	ARBOR	INSERTS (10 PCS)		
P	03273426	DQ14 2.00P KIT	R220.54-02.00-14-4A	2.00	0.75	SNMX 1407ANTR-M10, MP2501	\$798	\$1,060
	03273427	DQ14 2.50P KIT	R220.54-02.50-14-5A	2.50	0.75	SNMX 1407ANTR-M10, MP2501	\$908	\$1,200
	03273428	DQ14 3.00P KIT	R220.54-03.00-14-6A	3.00	1.00	SNMX 1407ANTR-M10, MP2501	\$1,010	\$1,330
	03273429	DQ14 4.00P KIT	R220.54-04.00-14-7A	4.00	1.50	SNMX 1407ANTR-M10, MP2501	\$1,180	\$1,570
M	03273431	DQ14 2.00M KIT	R220.54-02.00-14-4A	2.00	0.75	SNMX 1407ANTR-M10, F40M	\$798	\$1,060
	03273432	DQ14 2.50M KIT	R220.54-02.50-14-5A	2.50	0.75	SNMX 1407ANTR-M10, F40M	\$908	\$1,200
	03273433	DQ14 3.00M KIT	R220.54-03.00-14-6A	3.00	1.00	SNMX 1407ANTR-M10, F40M	\$1,010	\$1,330
	03273434	DQ14 4.00M KIT	R220.54-04.00-14-7A	4.00	1.50	SNMX 1407ANTR-M10, F40M	\$1,180	\$1,570

Kit includes one cutter body, ten inserts, and a wrench

FEATURED GRADES

- MP2501
- F40M



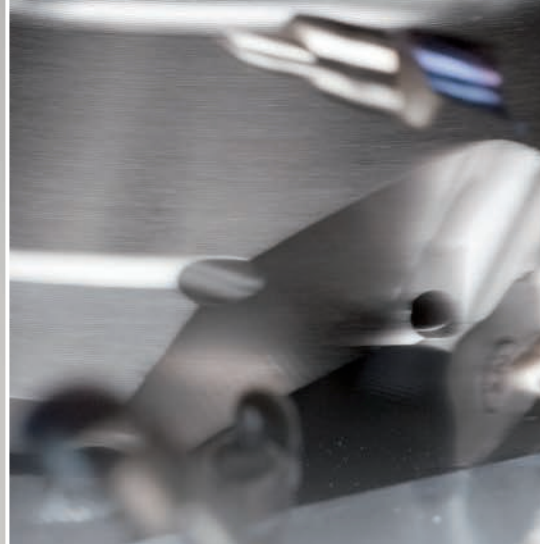

ENJOY FREE CUTTING CAPABILITY IN ALL MATERIALS

Excel in any machining conditions with the **Quattromill 09 & 12**. It's free cutting design and wide range of inserts create excellent surface finished in all workpiece materials. All Quattromill cutter bodies are coated for longer tool life, and their strong, square inserts are easy to index. The Quattromill 09 diameter range begins at 1.50" and is ideal for precision machining on light duty machines. Quattromill 12 increases depth of cut due to insert size for higher feed and metal removal rates.



R220.53-12 CUTTERS & SEMX/SEEX INSERTS - MAX DEPTH OF CUT 0.236"

	ITEM NUMBER	KIT DESCRIPTION	KIT CONTENTS				KIT PRICE (USD)	KIT PRICE (CAD)
			CUTTER	DIA	BORE	INSERT (10 PCS.)		
P	02629027	QUATTRO-12 2.00P KIT	R220.53-02.00-12-4A	2.00	0.75	SEMX 1204AFN-M15 MP2501	\$660	\$830
	02629031	QUATTRO-12 3.00P KIT	R220.53-03.00-12-6A	3.00	1.00	SEMX 1204AFN-M15 MP2501	\$825	\$1,040
M	02629035	QUATTRO-12 2.00M KIT	R220.53-02.00-12-4A	2.00	0.75	SEEX 1204AFN-M08 F40M	\$693	\$870
	02629039	QUATTRO-12 3.00M KIT	R220.53-03.00-12-6A	3.00	1.00	SEEX 1204AFN-M08 F40M	\$858	\$1,080

Kits include one cutter body, ten inserts, and a wrench

FEATURED GRADES

- MP2501
- F40M





FACE MILLING HIGH FEED 2 KITS

GAIN IMPROVED ECONOMY IN HIGH FEED MILLING

Machine up to three times faster than conventional methods. Pairing shallow depth of cut with high feed per tooth increases metal removal rates resulting in more parts being machined. The **High Feed 2** comes in two insert sizes and is single sided. The diameter range begins as small as 0.500" and is excellent in all materials.



HIGH FEED 2

	ITEM NUMBER	KIT DESCRIPTION	KIT CONTENTS				KIT PRICE (USD)	KIT PRICE (CAD)	
			CUTTER	DIA	BORE	SHANK			INSERT (10 PCS.)
P	02874480	HIGHFEED2 .625P KIT	R217.21-0.625.0-LP06.2A	0.625	-	0.625	LPHW 060310TR-MD07 MP2501	\$369	\$465
	02874481	HIGHFEED2 .750P KIT	R217.21-0.75.0-LP06.2A	0.750	-	0.750	LPHW 060310TR-MD07 MP2501	\$383	\$487
	02874482	HIGHFEED2 1.00P KIT	R217.21-1.00.0-LP06.3A	1.000	-	1.000	LPHW 060310TR-MD07 MP2501	\$420	\$532
M	02874483	HIGHFEED2 .625M KIT	R217.21-0.625.0-LP06.2A	0.625	-	0.625	LPHT 060310TR-M06 F40M	\$369	\$465
	02874484	HIGHFEED2 .750M KIT	R217.21-0.75.0-LP06.2A	0.750	-	0.750	LPHT 060310TR-M06 F40M	\$383	\$487
	02874516	HIGHFEED2 1.00M KIT	R217.21-1.00.0-LP06.3A	1.000	-	1.000	LPHT 060310TR-M06 F40M	\$420	\$532

FEATURED GRADES

- MP2501
- F40M



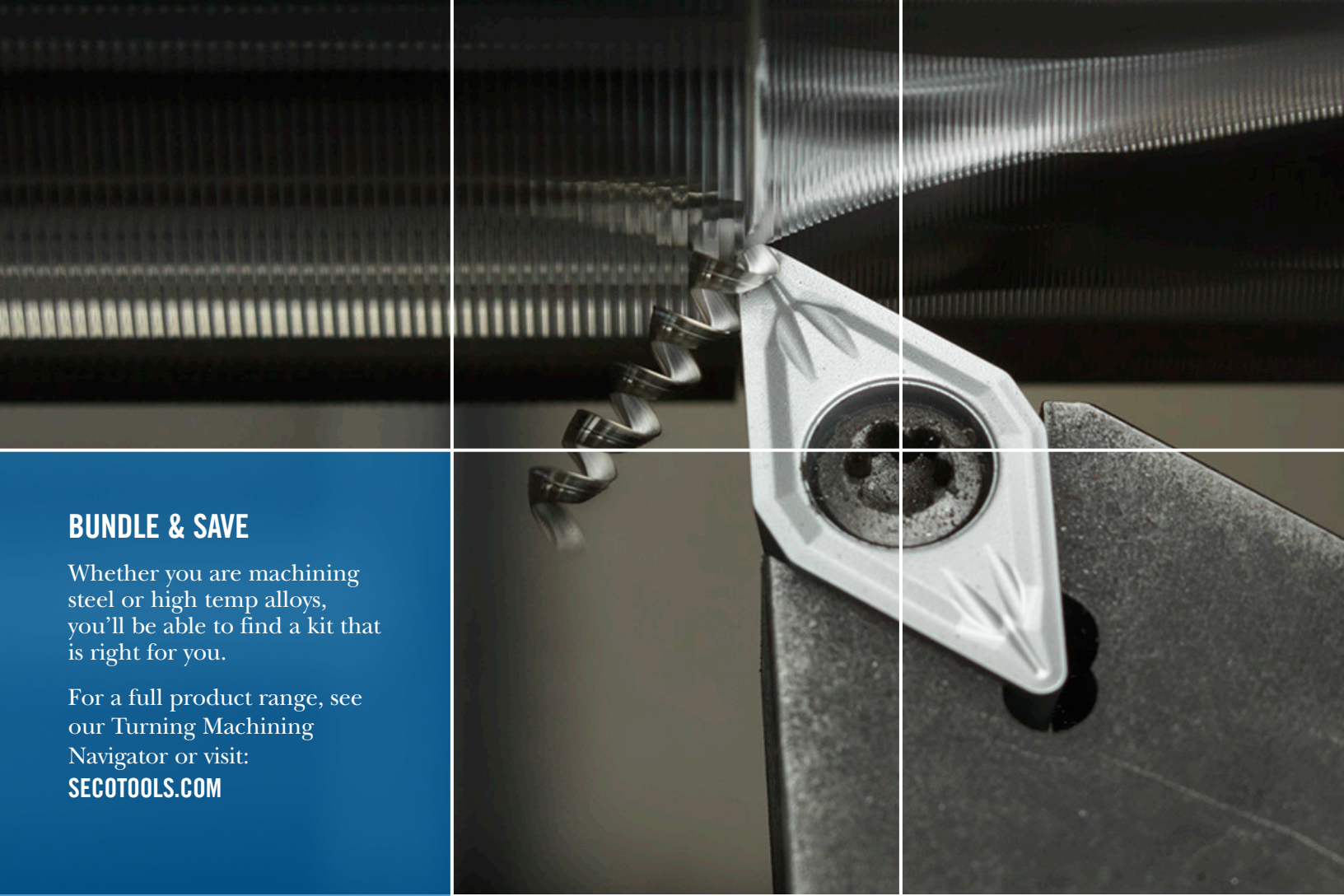

BUNDLE & SAVE

Whether you are machining steel or high temp alloys, you'll be able to find a kit that is right for you.

For a full product range, see our Turning Machining Navigator or visit:

SECOTOOLS.COM

TURNING, GROOVING, THREADING, & CUT-OFF **STATIONARY KITS**



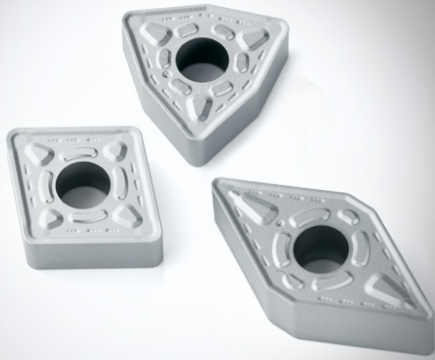

TURNING

DURATOMIC® STEEL KITS

NEVER WASTE ANOTHER INSERT WITH USED EDGE DETECTION

Featuring **Duratomic** chrome technology, these steel turning kits are now available in three grades, including TP1501, TP2501, and TP3501. Advanced geometries for general machining and profiling and a 1.0” toolholder ensure you can find what you need. The “D” style holders draw inserts down and back into the pocket for more secure insert holding.

FEATURED GRADES

- TP3501
- TP2501
- TP1501



1.0” RIGHT & LEFT HAND TOOLHOLDERS & CNMG/DNMG/WNMG INSERTS

	ITEM NUMBER	KIT DISCRPTION	TOOL	INSERT (10 PCS.)	KIT PRICE (USD)	KIT PRICE (CAD)
FINISH	02874112	TRN 1.0 RH CNMG 432-MF2 TP1501	DCLNR-16-4D	CNMG 432-MF2 TP1501	\$185	\$236
	02874113	TRN 1.0 LH CNMG 432-MF2 TP1501	DCLNL-16-4D	CNMG 432-MF2 TP1501	\$185	\$236
	02874114	TRN 1.0 RH DNMG 432-MF2 TP1501	DDJNR-16-4D-M	DNMG 432-MF2 TP1501	\$218	\$276
	02874115	TRN 1.0 LH DNMG 432-MF2 TP1501	DDJNL-16-4D-M	DNMG 432-MF2 TP1501	\$218	\$276
	03172982	TRN 1.0 RH DNMG 432-M3 TP1501	DDJNR-16-4D-M	DNMG 432-M3 TP1501	\$196	\$251
	03172983	TRN 1.0 LH DNMG 432-M3 TP1501	DDJNL-16-4D-M	DNMG 432-M3 TP1501	\$196	\$251
	03172984	TRN 1.0 RH VNMG 332-M3 TP1501	DVJNR-16-3C	VNMG 332-M3 TP1501	\$185	\$236
	03172985	TRN 1.0 LH VNMG 332-M3 TP1501	DVJNL-16-3C	VNMG 332-M3 TP1501	\$185	\$236
	03172988	TRN 1.0 RH DNMG 432-M3 TP2501	DDJNR-16-4D-M	DNMG 432-M3 TP2501	\$196	\$251
	03172989	TRN 1.0 LH DNMG 432-M3 TP2501	DDJNL-16-4D-M	DNMG 432-M3 TP2501	\$196	\$251
	02864153	TRN 1.0 RH CNMG 432-M3 TP1501	DCLNR-16-4D	CNMG 432-M3 TP1501	\$185	\$236
	02864168	TRN 1.0 LH CNMG 432-M3 TP1501	DCLNL-16-4D	CNMG 432-M3 TP1501	\$185	\$236
	02580500	TRN 1.0 RH CNMG 432-MF5 TP2501	DCLNR-16-4D	CNMG 432-MF5 TP2501	\$185	\$236
	02580510	TRN 1.0 LH CNMG 432-MF5 TP2501	DCLNL-16-4D	CNMG 432-MF5 TP2501	\$185	\$236
	MEDIUM	02631961	TRN 1.0 RH CNMG 432-M5 TP1501	DCLNR-16-4D	CNMG 432-M5 TP1501	\$185
02631962		TRN 1.0 LH CNMG 432-M5 TP1501	DCLNL-16-4D	CNMG 432-M5 TP1501	\$185	\$236
02874116		TRN 1.0 RH WNMG 432-M5 TP1501	DWLNR-16-4D	WNMG 432-M5 TP1501	\$196	\$251
02874117		TRN 1.0 LH WNMG 432-M5 TP1501	DWLNL-16-4D	WNMG 432-M5 TP1501	\$196	\$251
02580520		TRN 1.0 RH WNMG 432-M3 TP2501	DWLNR-16-4D	WNMG 432-M3 TP2501	\$196	\$251
02580529		TRN 1.0 LH WNMG 432-M3 TP2501	DWLNL-16-4D	WNMG 432-M3 TP2501	\$196	\$251
03172980		TRN 1.0 RH WNMG 432-M3 TP1501	DWLNR-16-4D	WNMG 432-M3 TP1501	\$196	\$251
03172981		TRN 1.0 LH WNMG 432-M3 TP1501	DWLNL-16-4D	WNMG 432-M3 TP1501	\$196	\$251
03172987		TRN 1.0 RH CNMG 432-M3 TP2501	DCLNR-16-4D	CNMG 432-M3 TP2501	\$185	\$236
03172986		TRN 1.0 LH CNMG 432-M3 TP2501	DCLNL-16-4D	CNMG 432-M3 TP2501	\$185	\$236
02874118		TRN 1.0 RH CNMG 432-M5 TP2501	DCLNR-16-4D	CNMG 432-M5 TP2501	\$185	\$236
02874119		TRN 1.0 LH CNMG 432-M5 TP2501	DCLNL-16-4D	CNMG 432-M5 TP2501	\$185	\$236
02874120		TRN 1.0 RH WNMG 432-M5 TP2501	DWLNR-16-4D	WNMG 432-M5 TP2501	\$196	\$251
02874121		TRN 1.0 LH WNMG 432-M5 TP2501	DWLNL-16-4D	WNMG 432-M5 TP2501	\$196	\$251
02864155		TRN 1.0 RH CNMG 432-M3 TP3501	DCLNR-16-4D	CNMG 432-M3 TP3501	\$185	\$236
02864170	TRN 1.0 LH CNMG 432-M3 TP3501	DCLNL-16-4D	CNMG 432-M3 TP3501	\$185	\$236	
02864165	TRN 1.0 RH WNMG 432-M5 TP3501	DWLNR-16-4D	WNMG 432-M5 TP3501	\$196	\$251	
02864173	TRN 1.0 LH WNMG 432-M5 TP3501	DWLNL-16-4D	WNMG 432-M5 TP3501	\$196	\$251	
ROUGH	03172990	TRN 1.0 RH CNMG 432-M5 TP3501	DCLNR-16-4D	CNMG 432-M5 TP3501	\$185	\$236
	03172991	TRN 1.0 LH CNMG 432-M5 TP3501	DCLNL-16-4D	CNMG 432-M5 TP3501	\$185	\$236

Kits include one toolholder, ten inserts, and a wrench



TURNING

DURATOMIC® TM GRADES KITS

DELIVER HIGHER PRODUCTIVITY IN STAINLESS STEEL

Take the machining difficulties out of turning stainless steels with Seco's **TM1501**, **TM2501** and **TM3501** grades, designed specifically for stainless steels.

FEATURED GRADES

- TM1501
- TM2501
- TM3501

These grades handle finishing, roughing and interrupted cuts in difficult alloys better than the previous generation and provide smoother part surface quality. Minimize typical tool life restricting wear modes common in stainless steel turning, such as notch wear, built-up-edge, and chipping.

1.0" RIGHT & LEFT HAND TOOLHOLDERS & CNMG/DNMG/WNMG INSERTS

	ITEM NUMBER	KIT DISCRPTION	TOOL	INSERT (10 PCS.)	KIT PRICE (USD)	KIT PRICE (CAD)
FINISH	03331793	TRN 1.0 RH DNMG432-MF4TM1501	DDJNR-16-4D-M	DNMG432-MF4 TM1501	\$218	\$276
	03331794	TRN 1.0 LH DNMG432-MF4TM1501	DDJNL-16-4D-M	DNMG432-MF4 TM1501	\$218	\$276
	03331796	TRN 1.0 LH VNMG331-MF4TM1501	DVJNL-16-3C	VNMG331-MF4 TM1501	\$296	\$376
	03331799	TRN 1.0 RH WNMG432-MF4TM3501	DWLN-16-4D	WNMG432-MF4 TM3501	\$200	\$252
	03331800	TRN 1.0 LH WNMG432-MF4TM3501	DWLN-16-4D	WNMG432-MF4 TM3501	\$200	\$252
	03331822	TRN 1.0 RH VNMG331-MF4TM1501	DVJNR-16-3C	VNMG331-MF4 TM1501	\$296	\$376
	03334139	TRN .75 RH WNMP431-MF1TM2501	DWLN-12-4B	WNMP431-MF1 TM2501	\$196	\$251
	03334140	TRN .75 LH WNMP431-MF1TM2501	DWLN-12-4B	WNMP431-MF1 TM2501	\$196	\$251
	03334141	TRN 1.0 RH CNMP432-MF1TM2501	DCLNR-16-4D	CNMP432-MF1 TM2501	\$188	\$237
	03334142	TRN 1.0 LH CNMP432-MF1TM2501	DCLNL-16-4D	CNMP432-MF1 TM2501	\$188	\$237
	03334143	TRN 1.0 RH CNMG432-MF4TM1501	DCLNR-16-4D	CNMG432-MF4 TM1501	\$188	\$237
	03334144	TRN 1.0 LH CNMG432-MF4TM1501	DCLNL-16-4D	CNMG432-MF4 TM1501	\$188	\$237
	03334145	TRN 1.0 RH WNMG432-MF4TM1501	DWLN-16-4D	WNMG432-MF4 TM1501	\$200	\$252
	03334146	TRN 1.0 LH WNMG432-MF4TM1501	DWLN-16-4D	WNMG432-MF4 TM1501	\$200	\$252
	03334147	TRN 1.0 RH CNMG432-MF4TM2501	DCLNR-16-4D	CNMG432-MF4 TM2501	\$188	\$237
03334148	TRN 1.0 LH CNMG432-MF4TM2501	DCLNL-16-4D	CNMG432-MF4 TM2501	\$188	\$237	
03334149	TRN 1.0 RH WNMG432-MF4TM2501	DWLN-16-4D	WNMG432-MF4 TM2501	\$200	\$252	
03334150	TRN 1.0 LH WNMG432-MF4TM2501	DWLN-16-4D	WNMG432-MF4 TM2501	\$200	\$252	
MEDIUM	03334151	TRN 1.0 RH WNMG432-M5TM2501	DWLN-16-4D	WNMG432-M5 TM2501	\$163	\$204
	03334152	TRN 1.0 LH WNMG432-M5TM2501	DWLN-16-4D	WNMG432-M5 TM2501	\$163	\$204
	03334153	TRN 1.0 RH CNMG432-M5TM1501	DCLNR-16-4D	CNMG432-M5 TM1501	\$188	\$237
	03334154	TRN 1.0 LH CNMG432-M5TM1501	DCLNL-16-4D	CNMG432-M5 TM1501	\$188	\$237
	03334155	TRN 1.0 RH CNMG432-M5TM2501	DCLNR-16-4D	CNMG432-M5 TM2501	\$188	\$237
	03334156	TRN 1.0 LH CNMG432-M5TM2501	DCLNL-16-4D	CNMG432-M5 TM2501	\$188	\$237
ROUGH	03331801	TRN 1.0 LH DNMG432-MR3TM3501	DDJNL-16-4D-M	DNMG432-MR3 TM3501	\$218	\$276
	03331797	TRN 1.0 RH CNMG432-MR3TM3501	DCLNR-16-4D	CNMG432-MR3 TM3501	\$188	\$237
	03331798	TRN 1.0 LH CNMG432-MR3TM3501	DCLNL-16-4D	CNMG432-MR3 TM3501	\$188	\$237
	03334157	TRN 1.0 RH CNMG432-MR7TM2501	DCLNR-16-4D	CNMG432-MR7 TM2501	\$188	\$237
	03334158	TRN 1.0 LH CNMG432-MR7TM2501	DCLNL-16-4D	CNMG432-MR7 TM2501	\$188	\$237
03331823	TRN 1.0 RH DNMG432-MR3TM3501	DDJNR-16-4D-M	DNMG432-MR3 TM3501	\$218	\$276	

Kits include one toolholder, ten inserts, and a wrench

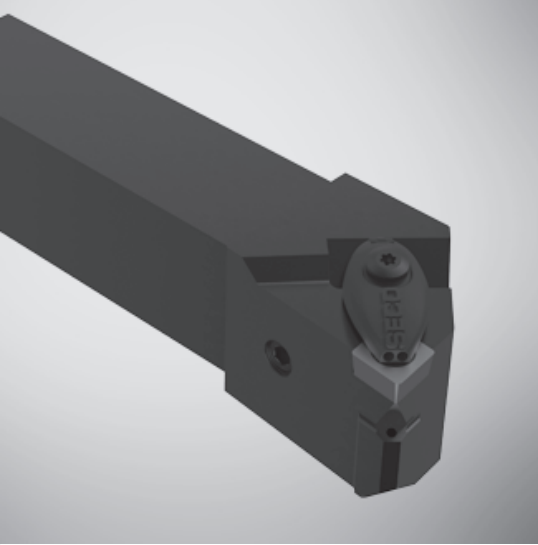

STAY COOL IN SUPERALLOYS

Jetstream Tooling is a revolutionary way to improve chip control in almost all materials. It is particularly effective on titanium and high temp alloys where chip control is problematic. We recommend a minimum pump pressure of 200 psi, but you'll see dramatic improvements in chip control, tool life, and the opportunity to use increased cutting speeds as the pressure is increased to 1000 psi.

FEATURED GRADES

- TS2000
- TS2500
- CP500



JET 1.0 RIGHT & LEFT HAND TOOLHOLDERS & CNMP/CNMG/DNMP/DNMG INSERTS

	ITEM NUMBER	KIT DESCRIPTION	TOOL	INSERT (10 PCS.)	KIT PRICE (USD)	KIT PRICE (CAD)
FINISH	02915774	JET 1.0 LH CNMP 432-MF1 CP500	DCLNL-16-4XJETI	CNMP 432-MF1 CP500	\$317	\$410
	02915767	JET 1.0 LH CNMP 432-MF1 TS2000	DCLNL-16-4XJETI	CNMP 432-MF1 TS2000	\$317	\$410
	02915792	JET 1.0 LH DNMP 431-MF1 TS2000	DDJNL-16-4XJETI	DNMP 431-MF1 TS2000	\$349	\$450
	02915794	JET 1.0 LH DNMP 432-MF1 TS2000	DDJNL-16-4XJETI	DNMP 432-MF1 TS2000	\$349	\$450
	02915770	JET 1.0 RH CNMP 432-MF1 CP500	DCLNR-16-4XJETI	CNMP 432-MF1 CP500	\$317	\$410
	02915761	JET 1.0 RH CNMP 432-MF1 TS2000	DCLNR-16-4XJETI	CNMP 432-MF1 TS2000	\$317	\$410
	02915791	JET 1.0 RH DNMP 431-MF1 TS2000	DDJNR-16-4XJETI	DNMP 431-MF1 TS2000	\$349	\$450
	02915793	JET 1.0 RH DNMP 432-MF1 TS2000	DDJNR-16-4XJETI	DNMP 432-MF1 TS2000	\$349	\$450
MEDIUM	02915783	JET 1.0 LH CNMG 432-MF4 CP500	DCLNL-16-4XJETI	CNMG 432-MF4 CP500	\$317	\$410
	02915779	JET 1.0 LH CNMG 432-MF4 TS2000	DCLNL-16-4XJETI	CNMG 432-MF4 TS2000	\$317	\$410
	02915781	JET 1.0 LH CNMG 432-MF4 TS2500	DCLNL-16-4XJETI	CNMG 432-MF4 TS2500	\$317	\$410
	02915782	JET 1.0 RH CNMG 432-MF4 CP500	DCLNR-16-4XJETI	CNMG 432-MF4 CP500	\$317	\$410
	02915778	JET 1.0 RH CNMG 432-MF4 TS2000	DCLNR-16-4XJETI	CNMG 432-MF4 TS2000	\$317	\$410
	02915780	JET 1.0 RH CNMG 432-MF4 TS2500	DCLNR-16-4XJETI	CNMG 432-MF4 TS2500	\$317	\$410
ROUGH	02915787	JET 1.0 LH CNMG 432-MR3 CP500	DCLNL-16-4XJETI	CNMG 432-MR3 CP500	\$317	\$410
	02915785	JET 1.0 LH CNMG 432-MR3 TS2000	DCLNL-16-4XJETI	CNMG 432-MR3 TS2000	\$317	\$410
	02915790	JET 1.0 LH CNMG 432-MR4 TS2500	DCLNL-16-4XJETI	CNMG 432-MR4 TS2500	\$317	\$410
	02915798	JET 1.0 LH DNMG 432-MR3 CP500	DDJNL-16-4XJETI	DNMG 432-MR3 CP500	\$343	\$436
	02915796	JET 1.0 LH DNMG 432-MR3 TS2000	DDJNL-16-4XJETI	DNMG 432-MR3 TS2000	\$349	\$450
	02915800	JET 1.0 LH DNMG 432-MR4 TS2500	DDJNL-16-4XJETI	DNMG 432-MR4 TS2500	\$349	\$450
	02915786	JET 1.0 RH CNMG 432-MR3 CP500	DCLNR-16-4XJETI	CNMG 432-MR3 CP500	\$317	\$410
	02915784	JET 1.0 RH CNMG 432-MR3 TS2000	DCLNR-16-4XJETI	CNMG 432-MR3 TS2000	\$317	\$410
	02915789	JET 1.0 RH CNMG 432-MR4 TS2500	DCLNR-16-4XJETI	CNMG 432-MR4 TS2500	\$317	\$410
	02915797	JET 1.0 RH DNMG 432-MR3 CP500	DDJNR-16-4XJETI	DNMG 432-MR3 CP500	\$343	\$436
02915795	JET 1.0 RH DNMG 432-MR3 TS2000	DDJNR-16-4XJETI	DNMG 432-MR3 TS2000	\$349	\$450	
02915799	JET 1.0 RH DNMG 432-MR4 TS2500	DDJNR-16-4XJETI	DNMG 432-MR4 TS2500	\$349	\$450	

Kits include one toolholder, ten inserts, and a wrench



TURN, GROOVE, CUT-OFF, AND PROFILE WITH ONE INSERT

MDT (Multi-Directional Turning & Grooving) handles profile turning, deep grooving and cut-off operations with one tool allowing fewer tool changes and reduced tool inventory. The unique **Secoloc™** v-shaped clamping delivers the superb stability and safety in addition to high productivity and performance. Since the MDT system can be used for straight turning, profiling, grooving and parting off, it replaces the need for several standard and special tools.

The **X4 system** incorporating 4-cutting-edge insert is optimized for cut-off and grooving primarily small parts like bars and tubes made from a wide variety of work materials. It consists of indexable tangential inserts and a highly stable clamp design with **Jetstream Tooling® Duo** coolant delivery providing optimal chip control and increased tool life. These strong, dependable system components achieve high accuracy, repeatability, productivity, and surface quality.

FEATURED GRADES

- CP500



Both incorporate CP500, a universal grade used in all materials.

MDT STANDARD & LONG REACH (LG) TOOLHOLDERS

	ITEM NUMBER	KIT DESCRIPTION	TOOL	INSERT (10 PCS.)	INSERT WIDTH (MM)	KIT PRICE (USD)	KIT PRICE (CAD)
	00093101	MDT 1.00 RH 3MM	CFIR 100 03D	LCMF 3MM FT, CP500	3	\$349	\$450
	00093103	MDT 1.00 RH 4MM	CFIR 100 04D	LCMF 4MM FT, CP500	4	\$349	\$450
	00093110	MDT 1.00 RH 5MM	CFIR 100 05D	LCMF 5MM FT, CP500	5	\$369	\$471
	00093111	MDT 1.00 RH 6MM	CFIR 100 06D	LCMF 6MM FT, CP500	6	\$401	\$511
	00093130	MDT 1.00 RH LG 3MM	CFMR 100 03D	LCMR 3MM FT, CP500	3	\$299	\$383
	00093139	MDT 1.00 RH LG 4MM	CFMR 100 04D	LCMR 4MM FT, CP500	4	\$299	\$383
	00093140	MDT 1.00 RH LG 5MM	CFMR 100 05D	LCMR 5MM FT, CP500	5	\$312	\$395
	00093150	MDT 1.00 RH LG 6MM	CFMR 100 06D	LCMR 6MM FT, CP500	6	\$343	\$436

X4 TOOLHOLDERS

	ITEM NUMBER	KIT DESCRIPTION	TOOL	INSERT (2 PCS.)	INSERT WIDTH (IN)	KIT PRICE (USD)	KIT PRICE (CAD)
	02895243	X4 1.00RH.031	X4FR 1002503DJET	X4GK 2503009-A0031RN-MC, CP500	0.031	\$337	\$428
	02895245	X4 1.00RH.047	X4FR 1002503DJET	X4GK 2503009-A0047RN-MC, CP500	0.047	\$337	\$428
	02895248	X4 1.00RH.062	X4FR 1002503DJET	X4GK 2503019-A0062RN-MC, CP500	0.062	\$337	\$428
	02895249	X4 1.00RH.072	X4FR 1002503DJET	X4GK 2503019-A0072RN-MC, CP500	0.072	\$337	\$428
	02895250	X4 1.00RH.094	X4FR 1002503DJET	X4GK 2503019-A0094RN-MC, CP500	0.094	\$337	\$428
	02895251	X4 1.00LH.031	X4FL 1002503DJET	X4GK 2503009-A0031LN-MC, CP500	0.031	\$337	\$428
	02895254	X4 1.00LH.047	X4FL 1002503DJET	X4GK 2503009-A0047LN-MC, CP500	0.047	\$337	\$428
	02895256	X4 1.00LH.062	X4FL 1002503DJET	X4GK 2503019-A0062LN-MC, CP500	0.062	\$337	\$428
	02895257	X4 1.00LH.072	X4FL 1002503DJET	X4GK 2503019-A0072LN-MC, CP500	0.072	\$337	\$428
	02895258	X4 1.00LH.094	X4FL 1002503DJET	X4GK 2503019-A0094LN-MC, CP500	0.094	\$337	\$428

Kits include one 1" toolholder, ten inserts, and a wrench



TURNING - CUT-OFF

150.10 CUT-OFF KITS

SAY GOODBYE TO LONG, TANGLED CHIPS

Get the right tools for high performance deep grooving and cut-off applications in low alloy steel and stainless steels. Diameters up to 5.5" are featured in each **150.10** cut-off tooling kit. You will receive one high speed steel cut-off blade that fits in a block type* toolholder, ten high-productivity inserts with the efficient -16 chipbreaker. And, as a bonus, an improved wrench to make insert installation and removal fast and easy.

FEATURED GRADES

- TGP45
- CP600



150.10A BLADES & TGP45 INSERTS

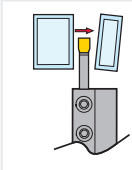

ITEM NUMBER	KIT DESCRIPTION	TOOL	INSERT (10 PCS.)	KIT PRICE (USD)	KIT PRICE (CAD)
02535302	150.10A 3MM TGP45 1.00	150.10A-20-3	150.10 3N-16-TGP45	\$256	\$321
02535303	150.10A 3MM TGP45 1.25	150.10A-25-3	150.10 3N-16-TGP45	\$261	\$336
02535304	150.10A 4MM TGP45 1.00	150.10A-20-4	150.10 4N-16-TGP45	\$266	\$342
02535305	150.10A 4MM TGP45 1.25	150.10A-25-4	150.10 4N-16-TGP45	\$273	\$349

150.10A BLADES & CP600 INSERTS

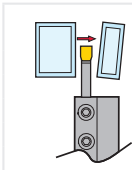

ITEM NUMBER	KIT DESCRIPTION	TOOL	INSERT (10 PCS.)	KIT PRICE (USD)	KIT PRICE (CAD)
02535306	150.10A 3MM CP600 1.00	150.10A-20-3	150.10 3N-16-CP600	\$256	\$321
02535307	150.10A 3MM CP600 1.25	150.10A-25-3	150.10 3N-16-CP600	\$261	\$336
02535308	150.10A 4MM CP600 1.00	150.10A-20-4	150.10 4N-16-CP600	\$266	\$342
02535309	150.10A 4MM CP600 1.25	150.10A-25-4	150.10 4N-16-CP600	\$273	\$349

Kits include one toolholder, ten inserts, and a wrench

*Block type toolholder ordered separately. Blade fits in most competitors blocks

THREADING

EXTERNAL THREADING FOR STEEL AND STAINLESS STEEL KITS

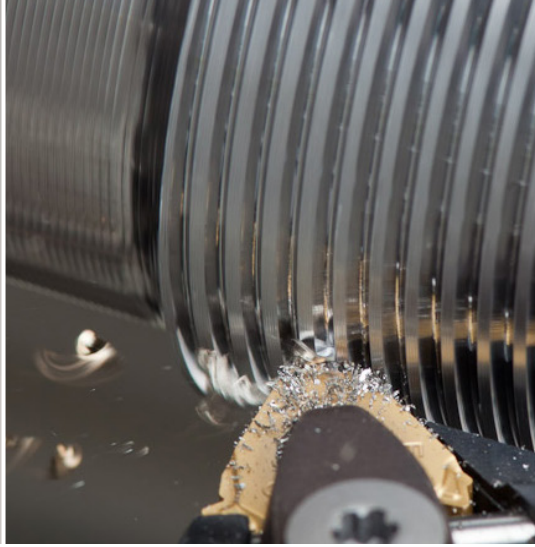

PRODUCE SUPERIOR THREAD SURFACE QUALITY

The Seco Tools “A1 & A2” insert chipbreaker geometries are optimized for steel and stainless steel threading respectively. Our **Snap-Tap®** threading kits feature the **HD holder** for maximum rigidity between insert and holder. Internal kits are also available.

FEATURED GRADES

- CP500



3/4" EXTERNAL THREADING HOLDERS & CP500 INSERTS - STEEL

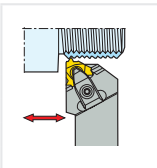

ITEM NUMBER	KIT DESCRIPTION	TOOL	INSERT (2 PCS.)	TPI	MM	KIT PRICE (USD)	KIT PRICE (CAD)
02517057	THD .750 EXTA PARTIAL-A1	CER 075 5-16QHD	16ERA60-A1 CP500	48-16	0.50-1.50	\$178	\$229
02517058	THD .750 EXTA GPARTIAL-A1	CER 075 5-16QHD	16ERAG60-A1 CP500	48-8	0.50-3.00	\$178	\$229
02517059	THD .750 EXT GPARTIAL-A1	CER 075 5-16QHD	16ERG60-A1 CP500	14-8	1.75-3.00	\$178	\$229

1" EXTERNAL THREADING HOLDERS & CP500 INSERTS - STEEL

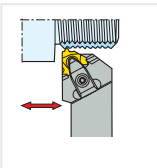

ITEM NUMBER	KIT DESCRIPTION	TOOL	INSERT (2 PCS.)	TPI	MM	KIT PRICE (USD)	KIT PRICE (CAD)
02517107	THD 1.00 EXT APARTIAL-A1	CER 100 6-16QHD	16ERA60-A1 CP500	48-16	0.50-1.50	\$190	\$241
02517108	THD 1.00 EXT AGPARTIAL-A1	CER 100 6-16QHD	16ERAG60-A1 CP500	48-8	0.50-3.00	\$190	\$241
02517109	THD 1.00 EXT GPARTIAL-A1	CER 100 6-16QHD	16ERG60-A1 CP500	14-8	1.75-3.00	\$190	\$241

3/4" EXTERNAL THREADING HOLDERS & CP500 INSERTS - STAINLESS STEEL

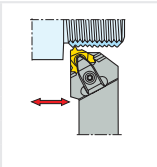

ITEM NUMBER	KIT DESCRIPTION	TOOL	INSERT (2 PCS.)	TPI	MM	KIT PRICE (USD)	KIT PRICE (CAD)
02517074	THD .750 EXT APARTIAL-A2	CER 075 5-16QHD	16ERA60-A2 CP500	48-16	0.50-1.50	\$178	\$229
02517075	THD .750 EXT AGPARTIAL-A2	CER 075 5-16QHD	16ERAG60-A2 CP500	48-8	0.50-3.00	\$178	\$229
02517076	THD .750 EXT GPARTIAL-A2	CER 075 5-16QHD	16ERG60-A2 CP500	14-8	1.75-3.00	\$178	\$229

1" EXTERNAL THREADING HOLDERS & CP500 INSERTS - STAINLESS STEEL

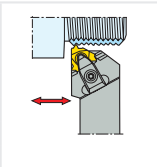

ITEM NUMBER	KIT DESCRIPTION	TOOL	INSERT (2 PCS.)	TPI	MM	KIT PRICE (USD)	KIT PRICE (CAD)
02517124	THD 1.00 EXT APARTIAL-A2	CER 100 6-16QHD	16ERA60-A2 CP500	48-16	0.50-1.50	\$190	\$241
02517125	THD 1.00 EXT AGPARTIAL-A2	CER 100 6-16QHD	16ERAG60-A2 CP500	48-8	0.50-3.00	\$190	\$241
02517126	THD 1.00 EXT GPARTIAL-A2	CER 100 6-16QHD	16ERG60-A2 CP500	14-8	1.75-3.00	\$190	\$241

0.75"-1.00" INTERNAL SNAP TAP/MINI SNAP TAP HOLDERS & CP500 INSERTS - STAINLESS STEEL

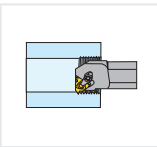

ITEM NUMBER	KIT DESCRIPTION	TOOL	INSERT (2 PCS.)	TPI	MM	KIT PRICE (USD)	KIT PRICE (CAD)
00093196	THD .750 RH SNAPTAP KIT ID	CNR 00075 7-16 AHD	16NR AG60 A2 CP500	48-8	0.50-3.00	\$217	\$276
00093180	THD 1.00 RH SNAPTAP KIT ID	CNR 00100 8-16 AHD	16NR AG60 A2 CP500	48-8	0.50-3.00	\$261	\$336

Kits include one toolholder, two inserts, and a wrench

Thread turning CNC code generation available on secotools.com product pages.

- Eliminate complicated programming
- Select the optimum holder and inserts
- Identify the best operating parameters

For cutting data recommendations and more visit: SECOTOOLS.COM





BUNDLE & SAVE

Find a kit that best fits your operation from a popular selection of drills and indexable holemaking cutters grouped into cost saving kits that are ideal for any application.

For a full range, see our Holemaking Navigator or visit: SECOTOOLS.COM

DRILLING HOLEMAKING KITS



DRILLING/ HOLEMAKING

PERFOMAX® KITS

GET A DRILL BODY THAT STANDS THE TEST OF TIME

Redesigned from front to back, the all new **Perfomax** drill body flutes feature a recently developed anti-friction surface or **“wave patterned technology”** to minimize the contact between chips and the flutes for higher application security and chip control optimization. Laser-hardened fronts of the flutes up to 60 HRC allows the drill to withstand chip erosion for much longer periods of time, yielding up to 40% longer drill body life.

FEATURED GRADES

- DP3000
- T400D



SD523 DRILL BODY & INSERTS - 3 X D, R7 & R7-C SHANKS, INCH

	ITEM NUMBER	KIT DESCRIPTION	KIT CONTENTS				KIT PRICE (USD)	KIT PRICE (CAD)	
			DRILL BODY	DRILL DIA	SHANK DIA	INSERTS (10 PCS)			INSERTS (10 PCS)
P	03171443	NG_PERFOMAX_625_3XD_KIT	SD523-0625-188-1000R7	0.625	1.00	SPGX0502-C1 T400D	SCGX050204-P2 DP3000	\$665	\$862
	03171444	NG_PERFOMAX_625_3XD_C_KIT	SD523-0625-188-1000R7-C	0.625	1.00	SPGX0502-C1 T400D	SCGX050204-P2 DP3000	\$665	\$862
	03171445	NG_PERFOMAX_750_3XD_KIT	SD523-0750-225-1000R7	0.750	1.00	SPGX0602-C1 T400D	SCGX050204-P2 DP3000	\$698	\$908
	03171446	NG_PERFOMAX_750_3XD_C_KIT	SD523-0750-225-1000R7-C	0.750	1.00	SPGX0602-C1 T400D	SCGX050204-P2 DP3000	\$698	\$908
	03171447	NG_PERFOMAX_875_3XD_KIT	SD5023-0875-263-1000R7	0.875	1.00	SPGX0703-C1 T400D	SCGX060204-P2 DP3000	\$719	\$928
	03171448	NG_PERFOMAX_875_3XD_C_KIT	SD523-0875-263-1000R7-C	0.875	1.00	SPGX0703-C1 T400D	SCGX060204-P2 DP3000	\$719	\$928
	03171449	NG_PERFOMAX_1.000_3XD_KIT	SD523-1000-300-1250R7	1.000	1.25	SPGX0703-C1 T400D	SCGX070308-P2 DP3000	\$736	\$955
	03171450	NG_PERFOMAX_1.000_3XD_C_KIT	SD523-1000-300-1250R7-C	1.000	1.25	SPGX0703-C1 T400D	SCGX070308-P2 DP3000	\$736	\$955
	03171451	NG_PERFOMAX_1.125_3XD_KIT	SD523-1125-338-1250R7	1.125	1.25	SPGX0903-C1 T400D	SCGX09T308-P2 DP3000	\$832	\$1,080
	03171452	NG_PERFOMAX_1.125_3XD_C_KIT	SD523-1125-338-1250R7-C	1.125	1.25	SPGX0903-C1 T400D	SCGX09T308-P2 DP3000	\$832	\$1,080
	03171453	NG_PERFOMAX_1.250_3XD_KIT	SD523-1250-375-1500R7	1.250	1.50	SPGX11T3-C1 T400D	SCGX09T308-P2 DP3000	\$845	\$1,090
	03171454	NG_PERFOMAX_1.250_3XD_C_KIT	SD523-1250-375-1500R7-C	1.250	1.50	SPGX11T3-C1 T400D	SCGX09T308-P2 DP3000	\$845	\$1,090
	03171455	NG_PERFOMAX_1.375_3XD_KIT	SD523-1375-413-1500R7	1.375	1.50	SPGX11T3-C1 T400D	SCGX11T308-P2 DP3000	\$914	\$1,190
	03171456	NG_PERFOMAX_1.375_3XD_C_KIT	SD523-1375-413-1500R7-C	1.375	1.50	SPGX11T3-C1 T400D	SCGX11T308-P2 DP3000	\$914	\$1,190
	03171457	NG_PERFOMAX_1.500_3XD_KIT	SD523-1500-450-1500R7	1.500	1.50	SPGX12T3-C1 T400D	SCGX11T308-P2 DP3000	\$933	\$1,220
	03171458	NG_PERFOMAX_1.500_3XD_C_KIT	SD523-1500-450-1500R7-C	1.500	1.50	SPGX12T3-C1 T400D	SCGX11T308-P2 DP3000	\$933	\$1,220

SD524 DRILL BODY & INSERTS - 4 X D, R7 & R7-C SHANKS, INCH

	ITEM NUMBER	KIT DESCRIPTION	KIT CONTENTS				KIT PRICE (USD)	KIT PRICE (CAD)	
			DRILL BODY	DRILL DIA	SHANK DIA	INSERTS (10 PCS)			INSERTS (10 PCS)
P	03171459	NG_PERFOMAX_625_4XD_KIT	SD524-0625-250-1000R7	0.625	1.00	SPGX0502-C1 T400D	SCGX050204-P2 DP3000	\$704	\$914
	03171460	NG_PERFOMAX_625_4XD_C_KIT	SD524-0625-250-1000R7-C	0.625	1.00	SPGX0502-C1 T400D	SCGX050204-P2 DP3000	\$704	\$914
	03171461	NG_PERFOMAX_750_4XD_KIT	SD524-0750-300-1000R7	0.750	1.00	SPGX0602-C1 T400D	SCGX050204-P2 DP3000	\$749	\$975
	03171462	NG_PERFOMAX_750_4XD_C_KIT	SD524-0750-300-1000R7-C	0.750	1.00	SPGX0602-C1 T400D	SCGX050204-P2 DP3000	\$749	\$975
	03171463	NG_PERFOMAX_875_4XD_KIT	SD524-0875-350-1000R7	0.875	1.00	SPGX0703-C1 T400D	SCGX060204-P2 DP3000	\$769	\$994
	03171464	NG_PERFOMAX_875_4XD_C_KIT	SD524-0875-350-1000R7-C	0.875	1.00	SPGX0703-C1 T400D	SCGX060204-P2 DP3000	\$769	\$994
	03171465	NG_PERFOMAX_1.000_4XD_KIT	SD524-1000-400-1250R7	1.000	1.25	SPGX0703-C1 T400D	SCGX070308-P2 DP3000	\$787	\$1,020
	03171466	NG_PERFOMAX_1.000_4XD_C_KIT	SD524-1000-400-1250R7-C	1.000	1.25	SPGX0703-C1 T400D	SCGX070308-P2 DP3000	\$787	\$1,020
	03171467	NG_PERFOMAX_1.125_4XD_KIT	SD524-1125-450-1250R7	1.125	1.25	SPGX0903-C1 T400D	SCGX09T308-P2 DP3000	\$890	\$1,150
	03171468	NG_PERFOMAX_1.125_4XD_C_KIT	SD524-1125-450-1250R7-C	1.125	1.25	SPGX0903-C1 T400D	SCGX09T308-P2 DP3000	\$890	\$1,150
	03171469	NG_PERFOMAX_1.250_4XD_KIT	SD524-1250-500-1500R7	1.250	1.50	SPGX11T3-C1 T400D	SCGX09T308-P2 DP3000	\$902	\$1,170
	03171470	NG_PERFOMAX_1.250_4XD_C_KIT	SD524-1250-500-1500R7-C	1.250	1.50	SPGX11T3-C1 T400D	SCGX09T308-P2 DP3000	\$902	\$1,170
	03171471	NG_PERFOMAX_1.375_4XD_KIT	SD524-1375-550-1500R7	1.375	1.50	SPGX11T3-C1 T400D	SCGX11T308-P2 DP3000	\$960	\$1,250
	03171472	NG_PERFOMAX_1.375_4XD_C_KIT	SD524-1375-550-1500R7-C	1.375	1.50	SPGX11T3-C1 T400D	SCGX11T308-P2 DP3000	\$960	\$1,250
	03171473	NG_PERFOMAX_1.500_4XD_KIT	SD524-1500-600-1500R7	1.500	1.50	SPGX12T3-C1 T400D	SCGX11T308-P2 DP3000	\$1,000	\$1,300
	03171474	NG_PERFOMAX_1.500_4XD_C_KIT	SD524-1500-600-1500R7-C	1.500	1.50	SPGX12T3-C1 T400D	SCGX11T308-P2 DP3000	\$1,000	\$1,300

Kits include one cutter body, 10 center, and 10 peripheral inserts

Note: R7 shanks for rotating applications / R7-C shanks for stationary application

For cutting data recommendations and more visit: SECOTOOLS.COM





DRILLING/ HOLEMAKING

FEEDMAX™ KITS

OPTIMIZE YOUR STEEL DRILLING

Increase productivity up to 35% with longer tool life, thanks to the combination of a new geometry and an advanced coating technology. The all new **Feedmax -P** drills for excellence in steel and iron drilling now have strong, straight cutting edges with coolant holes close by for pinpointed cutting edge cooling. Design features such as increased corner chamfers protect the drill point and provide exceptional chip control and evacuation to ensure application security. Drill more holes in a shorter amount of time and use fewer drills to do so.

FEATURED COATING

- TiAIN



TAP DRILLS - 5 x D

	ITEM NUMBER	KIT DESCRIPTION	KIT CONTENTS (INCH)			KIT PRICE (USD)	KIT PRICE (CAD)
			DRILLS (2 PCS)	DRILL DIA	SHANK DIA		
P	03171482	NG_FEEDMAX_8-32_KIT	SD205A-0350-023-06R1-P	0.138	0.236	\$222	\$290
	03171483	NG_FEEDMAX_10-24_KIT	SD205A-0390-029-06R1-P	0.154	0.236	\$222	\$290
	03171484	NG_FEEDMAX_1/4-20_KIT	SD205A-0510-035-06R1-P	0.201	0.236	\$222	\$290
	03171485	NG_FEEDMAX_5/16-18_KIT	SD205A-0660-043-08R1-P	0.260	0.315	\$261	\$336
	03171486	NG_FEEDMAX_3/8-16_KIT	SD205A-0800-043-08R1-P	0.315	0.315	\$261	\$336
	03171487	NG_FEEDMAX_7/16-14_KIT	SD205A-0990-049-10R1-P	0.390	0.394	\$317	\$410
	03171488	NG_FEEDMAX_1/2-13_KIT	SD205A-1080-056-12R1-P	0.425	0.472	\$432	\$559

Kits include two drills

TAP DRILLS - 5 x D

	ITEM NUMBER	KIT DESCRIPTION	KIT CONTENTS (METRIC)			KIT PRICE (USD)	KIT PRICE (CAD)
			DRILLS (2 PCS)	DRILL DIA	SHANK DIA		
P	03171475	NG_FEEDMAX_M4_KIT	SD205A-0330-023-06R1-P	3.3	6	\$222	\$290
	03171476	NG_FEEDMAX_M5_KIT	SD205A-0420-029-06R1-P	4.2	6	\$222	\$290
	03171477	NG_FEEDMAX_M6_KIT	SD205A-0500-035-06R1-P	5.0	6	\$222	\$290
	03171478	NG_FEEDMAX_M8_KIT	SD205A-0680-043-08R1-P	6.8	8	\$261	\$336
	03171479	NG_FEEDMAX_M10_KIT	SD205A-0850-049-10R1-P	8.5	10	\$317	\$410
	03171480	NG_FEEDMAX_M12_KIT	SD205A-1020-056-12R1-P	10.2	12	\$432	\$559
	03171481	NG_FEEDMAX_M14_KIT	SD205A-1200-056-12R1-P	12.0	12	\$432	\$559

Kits include two drills

Note: -P Geometry can also be used in iron and hardened steel



IMPROVE CHIP FORMATION AND REDUCE BUILD-UP

Crownloc® Plus drills are the economical, convenient way to achieve the holemaking tolerance of a brazed drill with superior metal removal rates. These drills don't need reconditioning, so they can be more cost-effective. The TiAlN coating on the exchangeable head and 10% micrograin substrate serve to increase toughness and wear resistance, while reducing the potential for edge build up.

- Optimized geometry for improved chip formation and enhanced centering capability for different work piece materials
- P geometry for drilling in steel and iron

FEATURED GRADES

- SD400



CROWNLOC PLUS SD403, 3 x D & SD400 TIPS

	ITEM NUMBER	KIT DESCRIPTION	KIT CONTENTS			KIT PRICE (USD)	KIT PRICE (CAD)	
			DRILL BODY	DRILL DIA	SHANK DIA			DRILL TIP (2 PCS)
P	03171422	CROWNLOC_PLUS.500_3XD_KIT	SD403-12.50/12.99-39-0625R1	0.500	0.625	SD400-12.70-P	\$489	\$626
	03171423	CROWNLOC_PLUS.532_3XD_KIT	SD403-13.00/13.99-42-0625R1	0.532	0.625	SD400-13.5-P	\$495	\$638
	03171424	CROWNLOC_PLUS.562_3XD_KIT	SD403-14.00/14.99-45-0625R1	0.562	0.625	SD400-14.288-P	\$508	\$654
	03171425	CROWNLOC_PLUS.594_3XD_KIT	SD403-15.00/15.99-48-0625R1	0.594	0.625	SD400-15.08-P	\$529	\$679
	03171426	CROWNLOC_PLUS.625_3XD_KIT	SD403-15.00/15.99-48-0625R1	0.625	0.625	SD400-15.875-P	\$529	\$679
	03171427	CROWNLOC_PLUS.656_3XD_KIT	SD403-16.00/16.99-51-0750R1	0.656	0.750	SD400-16.669-P	\$552	\$712
	03171428	CROWNLOC_PLUS.687_3XD_KIT	SD403-17.00/17.99-54-0750R1	0.687	0.750	SD400-17.463-P	\$552	\$712
	03171430	CROWNLOC_PLUS.719_3XD_KIT	SD403-18.00/18.99-57-0750R1	0.719	0.750	SD400-18.256-P	\$616	\$790
	03171431	CROWNLOC_PLUS.750_3XD_KIT	SD403-19.00/19.99-60-0750R1	0.750	0.750	SD400-19.05-P	\$622	\$804
	03171432	CROWNLOC_PLUS.781_3XD_KIT	SD403-19.00/19.99-60-0750R1	0.781	0.750	SD400-19.844-P	\$622	\$804

CROWNLOC PLUS SD405, 5 x D & SD400 TIPS

	ITEM NUMBER	KIT DESCRIPTION	KIT CONTENTS			KIT PRICE (USD)	KIT PRICE (CAD)	
			DRILL BODY	DRILL DIA	SHANK DIA			DRILL TIP (2 PCS)
P	03171433	CROWNLOC_PLUS.500_5XD_KIT	SD405-12.50/12.99-65-0625R1	0.500	0.625	SD400-12.70-P	\$545	\$704
	03171434	CROWNLOC_PLUS.532_5XD_KIT	SD405-13.00/13.99-70-0625R1	0.532	0.625	SD400-13.5-P	\$552	\$712
	03171435	CROWNLOC_PLUS.562_5XD_KIT	SD405-14.00/14.99-75-0625R1	0.562	0.625	SD400-14.288-P	\$566	\$724
	03171436	CROWNLOC_PLUS.594_5XD_KIT	SD405-15.00/15.99-80-0625R1	0.594	0.625	SD400-15.08-P	\$583	\$751
	03171437	CROWNLOC_PLUS.625_5XD_KIT	SD405-15.00/15.99-80-0625R1	0.625	0.625	SD400-15.875-P	\$583	\$751
	03171438	CROWNLOC_PLUS.656_5XD_KIT	SD405-16.00/16.99-85-0750R1	0.656	0.750	SD400-16.669-P	\$610	\$783
	03171439	CROWNLOC_PLUS.687_5XD_KIT	SD405-17.00/17.99-90-0750R1	0.687	0.750	SD400-17.463-P	\$610	\$783
	03171440	CROWNLOC_PLUS.719_5XD_KIT	SD405-18.00/18.99-95-0750R1	0.719	0.750	SD400-18.256-P	\$687	\$880
	03171441	CROWNLOC_PLUS.750_5XD_KIT	SD405-19.00/19.99-100-0750R1	0.750	0.750	SD400-19.05-P	\$693	\$887
	03171442	CROWNLOC_PLUS.781_5XD_KIT	SD405-19.00/19.99-100-0750R1	0.781	0.750	SD400-19.844-P	\$693	\$887

Kits include one drill body, 2 tips, and a wrench

**EVERYTHING
SECO TOOLS
AT YOUR
FINGERTIPS**



ACHIEVE MORE WITH YOUR METAL CUTTING SOLUTIONS SECO ASSISTANT APP

No internet? No problem. When there's no internet connection you can search Seco products; calculate feeds, speed, material removal rates for any brand, as well search and compare indexable inserts from other manufacturers.

Seco Assistant, an all-in-one mobile app, makes it easy to find metal cutting solutions that work for you without leaving the production floor.

Achieve all of your indexable application needs:

- Keep current data on our over 30,000 standard products in your pocket
- Quickly share lists of Favorite tools with your team
- Easily access product details by scanning the bar code on Seco Tools packaging
- Utilize offline features such as machining calculators



For technical assistance, call:
1-800-TEC-TEAM

For customer service, call:
1-248-528-5220

SECO TOOLS, LLC
NORTH AMERICAN HEADQUARTERS
2805 Bellingham Drive
Troy, MI 48083
248-528-5200

SECOTOOLS.COM

P-2305-2500 GT23-101
Copyright © 2023 Seco Tools, LLC
Printed in USA. All rights reserved.

Follow Seco Tools on Twitter, Facebook, YouTube, and LinkedIn. Stay up to date on new products and technology, special events, promotions, and more.

@SECOTOOLS
@SECOTOOLSUS

